

60PC1DC

60" Plasma Integrated HDTV



REMOVABLE STAND INCLUDED



- Built-in ATSC/NTSC/QAM Clear Tuners
- **New** "Public Display Settings" – Cloneable with TVLink-Loader
- 1366 x 768 Native Display Resolution
- 7,000:1 Contrast Ratio
- 1,200 cd/m² High Brightness
- 2 HDMI™ Inputs with HDCP
- LG's Exclusive XD Engine
- Warranty 2 Years



At a blazingly fast 370 million pixels per second, the processor uses a histogram analysis tool to clarify the image data according to signal brightness levels.

The minimum black level of an image is automatically detected and adjusted according to brightness.

Using the noise filter inside the XD Engine® chip, the image is analyzed for temporal and spatial information to reduce MPEG noise.

Colors that are sensitive to the human eye are optimized to the nearest TRUE color by the Selective Color Control.

Edge lines are emphasized by improving the transition from the background to the main object.

ULTRA CONTRAST

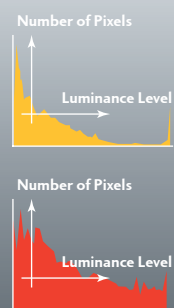

DYNAMIC BLACK STRETCH

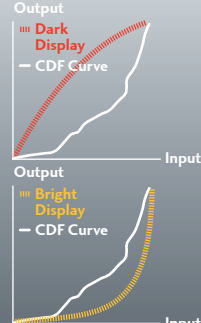
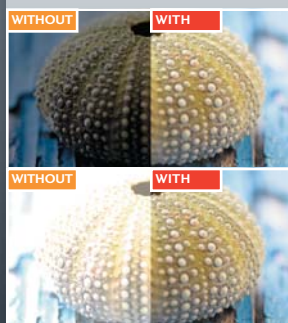

CLEAR SCREEN

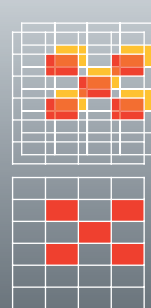

ADVANCED VIVID COLOR

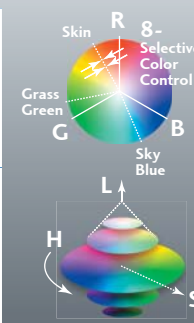
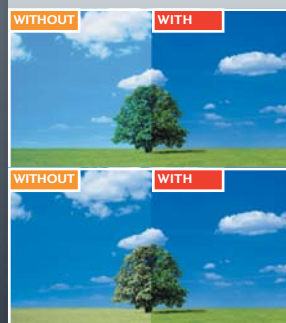

INTELLIGENT EDGE CONTROL

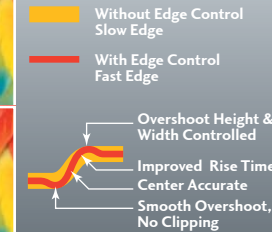

LG's exclusive XD Engine® takes the low resolution of analog signals to near HD levels by improving brightness, contrast, detail and enhancing color as well as reducing signal noise. This total solution results in cinema-like high resolution images.

PUBLIC DISPLAY SETTINGS

When used in public areas, these HDTVs can be easily programmed by the installer to have the TV turn on at a specified channel/volume level, set the minimum/maximum volume, lock out the control panel/remote, set the aspect ratio, and return to a factory reset. By using Power Management, these displays can be programmed to turn off if there has been no activity (remote or control panel buttons) for a preset time (1-7) hours.

Public Display Settings	
Public Display Mode	Yes
Start Channel	Yes
Ch. Type	DTV
Major	12
Minor	2
Minimum Volume	0
Maximum Volume	100
Start Volume	Yes
Level	15
Power Management	Yes
Setting	7
Key Management	0
Factory Reset	0
Aspect Ratio	0

TVLINK-LOADER TLL-1100A

By using the handheld, rechargeable TVLink-Loader, the installer can "clone" the Public Display Settings from one TV and then transfer this information quickly to many other TVs that have this feature.



SPECIFICATIONS

Plasma Module

Screen Size	60"
Native Display Resolution	1366 x 768
Contrast Ratio	7,000:1
Brightness	1,200 cd/m ²
Life Span	60,000 hours to Half Brightness
High Contrast Screen w/Non-Glare Coating	Glass Filter
Viewing Angle	Over 160°

Video

ATSC/NTSC/QAM Clear Tuners	Built-in
Digital Comb Filter	3D Y/C
Color Temperature Adjustment	4 Modes
3:2 Pulldown Cinema Correction	480i Only
Aspect Ratio Adjustment	6 Modes
EZ Video/Picture Selection Modes	5 Modes
XD Engine®	Yes
Black Stretcher (Black Level Enhancer)	Yes
DTV Signal Strength Indicator	Yes
Displayable Colors	1.07 Billion
Image Sticking Minimization	White Wash, Pixel Orbiter, Inversion
Decoder Format	MPEG2
Pixel Pitch	966µm (H) x 966µm (V)
DLTI (Digital Luminance Transient Improver)	Yes
DCTI (Digital Color Transient Improver)	Yes

Rear Inputs

Antenna/Cable In (RF)	1
HDMI™ with HDCP (DVI with Adapter)	2
Composite Video & Audio L/R In	1
S-Video In	1
Component HD/DVD & Audio L/R In	2
RGB In (PC/DTV Input)	1
Audio In (RGB /DVI with Adapter)	1
RS-232C In (Control / Service)	1
Remote Control In (IR)	1
USB	1 (Service)

Rear Outputs

Composite Video & Audio L/R Out	1
Digital Audio Out (Optical)	1

Side Inputs

Composite Video & Audio L/R In	1
S-Video In	1

UPC

7 9192 17256 2

Audio

Audio Output Power	20W (10W x 2)
Speaker System Details	2 Way 4 Speaker
Surround System Type	SRS TruSurround XT
Mono / MTS Stereo / SAP	Yes
EZ Sound / Sound Selection Mode	6 Modes
Mute	Yes
EZ SoundRite (Auto Volume Leveler)	Yes
Bass / Treble / Balance	Yes
3D EchoSound System	Yes

Special Features

Custom Input Labels	Yes
Trilingual Menus	English, Spanish, French
EZ Menus (High Performance Interface)	Yes
EZ Scan (Auto Channel Programming)	Yes
Favorite Channel Selection / Surf	Yes
Flashback (Previous Channel)	Yes
Closed Caption	Yes
Intelligent Fan Control	Yes
Parental Control w/ V-Chip	Yes
On / Off Timer	Yes
Sleep Timer	Yes (10 min. to 240 min.)
Auto Off (When no video is present)	Yes (After 10 minutes)
Auto Clock / Manual Clock	Yes
Auto Input Detect	Yes
Channel Block	Yes
Discrete IR Codes	Yes
1080p Source Input	Yes

Cabinet

Cabinet Style	Table Top
Table Stand Included	Yes
Cabinet Color	Black
Stand Color	Black
Dimensions with Stand (W x H x D)	60.8" x 40.8" x 16.1"
without Stand (W x H x D)	60.8" x 38.5" x 4.7"
packaging (W x H x D)	67.2" x 45.7" x 20.3"
Weight with Stand	163.1 lbs (73.9 Kg)
Weight without Stand	137.3 lbs (62.3 Kg)
Weight with packaging	189.2 lbs (85.8 Kg)
VESA™ Compatible	600mm x 400mm, M8 Screw

Operating Environments

Storage Temperature Range	-4°F to 140°F (-20°C to 60°C)
Storage Humidity Range	under 85%
Altitude	under 2,000m (under 6,561 ft.)
Operating Temperature	32°F to 104°F (0°C to 40°C)
Operating Humidity Range	under 80%

Required Listing

UL, c-UL, FCC	Yes
RoHS Compliant	Yes

Service / Limited Warranty

Warranty	2 Years Parts / Labor
----------	-----------------------

Accessories

Supplied accessories:	Owners Manual Power Cord (6 foot) LG Universal Remote Control 75Ω Round Cable (10 foot)
-----------------------	--

Compatible Formats

HDTV, NTSC, VGA, SVGA, XGA	Yes
Maximum Computer Resolution (RGB)	1366 x 768

Power

Power Consumption	700 Watts / 3 Watts in Standby
Power Source	AC 100 - 240V ~ 50 / 60 Hz
Energy Star Compliant	Yes

REAR JACKS

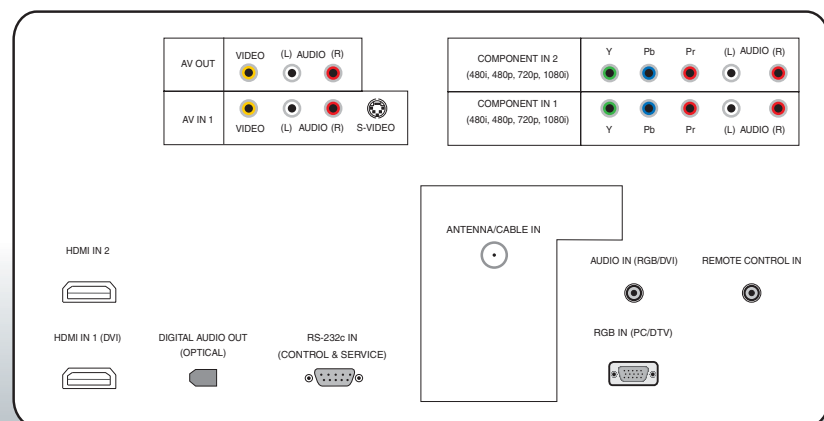

SIDE JACKS

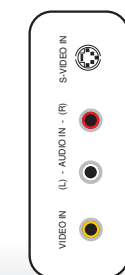

REMOTE (included)



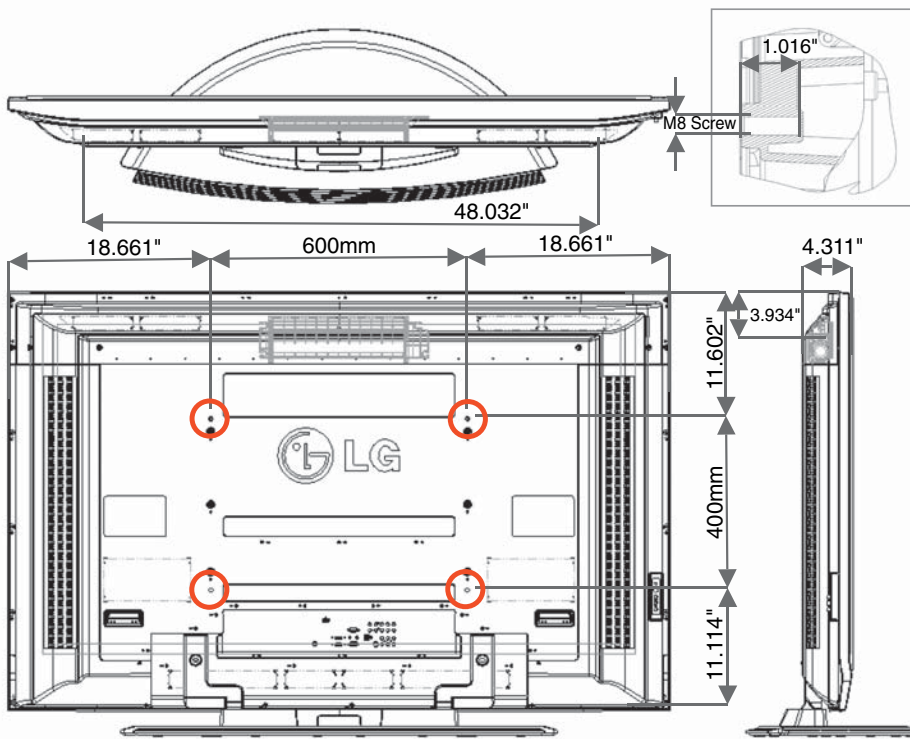
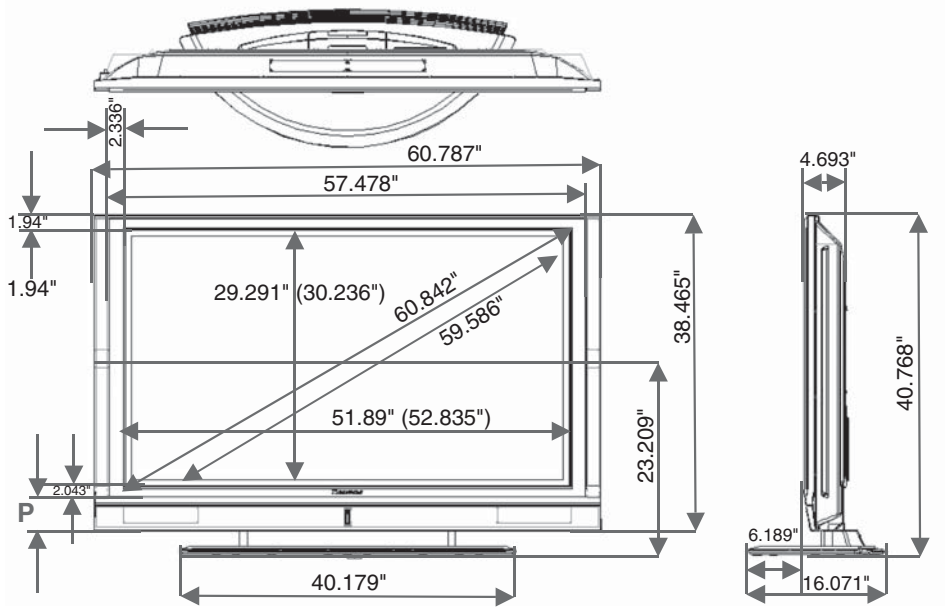

**PWMT300 FIXED OR
 TILTING WALL MOUNT**



The PWMT300 Flat Panel Modular Wall Mount's intuitive design makes it easy to mount a PC1 Series Plasma with the expandable brackets and the three included wall plates. Using this wall mount, the PC1 Series Plasmas can be hung flat or tilted +15°/-5° for viewing flexibility.

The PWMT300 is a Peerless® mount that is available for order at LG Electronics USA, Inc.

www.LGcommercial.com

LG ELECTRONICS USA, INC.
 Commercial Products Division

2000 Millbrook Drive, Lincolnshire, IL 60069 Customer Service: 1-888-865-3026

Contact your LG Regional Sales Manager Toll-Free – Healthcare: 877-793-6484; Hospitality: 1-800-228-1236; B2B: 1-800-897-8788;
 Channel Markets: 1-800-897-8871

Dimensions and weights are approximate. Design and specifications subject to change without notice. VESA™ is a registered trademark of Video Electronics Standards Association. The "LG Life's Good" is a registered trademark of LG Electronics USA, Inc. ProIdiom™ and MPI™ are trademarks of Zenith Electronics Corporation. Peerless is a registered trademark of Peerless Industries, Inc. All other corporate and brand names are trademarks of their respective owners. ©2007 LG Electronics USA, Inc. Printed in the USA. August 2007

18170LG60PC1DC0807

